

# A New Single-Display Intelligent Adaptive Interface for Controlling a Group of Unmanned Aerial Vehicles

M. Ilbeygi\* and M.- R. Kangavari

*Iran University of Science and Technology (IUST), Tehran, Iran.*

Received 18 April 2018; Revised 29 December 2018; Accepted 23 January 2019

\*Corresponding author: mahdi\_ilbeygi@iust.ac.ir(M. Ilbeygi).

## Abstract

The increasing use of unmanned aerial vehicles (UAVs) or drones in different civil and military operations has attracted the attentions of many researchers and science communities. One of the most notable challenges in this field is supervising and controlling a group or a team of UAVs by a single user. Thereupon, we propose a new intelligent adaptive interface (IAI) to overcome this challenge. Our proposed IAI is not only empowered by comprehensive IAI architecture but also has some notable features like presenting a single-display user interface for controlling a UAV team, leveraging the user cognitive model to deliver the right information at the right time, supporting the user by the system behavior explanation, and guiding and helping the user to choose the right decisions. Finally, we examine the developed IAI with the contribution of eleven volunteers and in three different scenarios. The results obtained show the power of the proposed IAI to reduce the workload and to increase the user's situation awareness level, and as a result, to promote the mission completion percentage.

**Keywords:** *Intelligent Adaptive Interface, Unmanned Aerial Vehicles, Single-Display User Interface, Situation Awareness, Cognitive Model, Forgetting Model.*

## 1. Introduction

Nowadays Unmanned (Uninhabited) Aerial Vehicles (UAVs) have gained significant attentions, and present brilliant capabilities in several civil and military operations. In many cases, an operation has been done by the cooperating members of a group of UAVs [1]. One of the most important challenges in such operations is how a single user can control a UAV team. If a UAV is not fully autonomous (that it is often proposed), controlling this UAV imposes a high workload on the user. This workload dramatically increases when the user controls a group or a team of UAVs [2, 3]. Thus, it is inevitable to design and implement an interface that enables the user to interact with and control multi-UAVs.

There are many complex aspects that must be considered in this context such as situation awareness, user cognitive model, adaptation with interaction context, and user cognitive assistance

and security. For example, it is ideal that we form an interaction between the user and UAVs (or robots) with a high level of situation awareness and simultaneously with a low level of workload. Considering these complex aspects of single human multiple UAV interaction in dynamic environment, an Intelligent Adaptive Interaction (IAI) mechanism is required to overcome the complexity of the interaction. IAI is an interface that dynamically adapts its control and displays characteristics to react in real time to task, user, system, and environment states [3].

Some of the interesting aspects of IAI have been reported and elaborated in the literature. For example, an IAI that focuses on situation awareness has been presented in [4]. Also a limited model-based context aware adaptive interface is presented in [5]. In addition, cognitive assistance adaptive interface for guidance of multiple UAVs has been introduced in [6]. It

should be noted that the adaptive recommenders such as [7] are also related to the field of IAI.

Heretofore, several works have been done in the field of interacting with UAVs using IAI. However, most articles have focused on a single topic of intelligent adaptive interfaces. For example, an adaptive interface only based upon the user situation awareness has been presented in [4] and named Intelligent Situation Awareness-Adaptive Interface (ISAAI). This IAI monitors the user situation awareness, only using eye gaze tracking and guide user visual attention to the relevant but unattended information. Thus, in this work, all the other important issues in designing an IAI were neglected.

Additionally, a conceptual architecture of IAI for controlling UAVs has been presented in [8], which has four main units: Situation Assessment and Support System, Operator State Assessment, Adaptation Engine, and Operator Machine Interface (OMI). The Situation Assessment and Operator State Assessment have been adequately addressed by this architecture but again, other issues like security, self-configuring, self-optimization, adapting knowledgebase based on new detected concepts in the context, and system state assessment have been omitted in this architecture.

Finally, we showed in this work that none of the reported research works had studied IAI in the field of single human multiple robot interaction thoroughly. Thus, we proposed a comprehensive architecture for interaction between a single human and a group of robots. Our architecture covers all the mentioned important aspects, as follows:

1. Adaptation to all interaction context changes like changes on user states, interaction environment, goals, and tasks.
2. Providing a framework for delivering the right information at the right time to the human user.
3. Performing a secure interaction with the lowest level of user intervention.
4. Supporting the user by cognitive assistance and system behavior explanation.
5. Considering self-configuration and self-optimization for the proposed architecture to update its knowledgebase over time.
6. Using ontology for modeling knowledge about concepts and relationships between them in the interaction environment.
7. Considering inter-relationship and

collaboration of robots in the interaction process.

8. Proposing a method to detect new concepts and relationships in the interaction context and modeling them into the ontology.
9. Providing continuous/active authentication by the user modeling and dedicated security unit.
10. Considering the user forgetting model for delivering information to him/her.

Finally, we designed and implemented an IAI for controlling a group of UAVs based on this architecture. Our new IAI also have some brilliant features such as:

- Delivering information based on the user's mental expectations
- Providing single display IAI for controlling multi-UAVs
- Temporal in-place UAV's camera display
- Temporal in-place user guideline
- Delivering information based on the user forgetting model
- Quick show concise explanation of system behavior
- Providing multi-modal interaction
- Intelligent adaptation of UAVs' icons luminance
- Providing very simple cryptography facilities
- Supplying single and group modes to command to UAVs

It must be noted that, based on our knowledge, some of these features (such as quick show concise explanation of system behavior and intelligent adaptation of UAVs' icons luminance) have not been presented in any previous work. Some of these features are not provided with the quality that we provided. For example, none of the previous works has used the SIMPLE forgetting model [9] to deliver information based on the user forgetting model. Aside from this, we have integrated all these features into a single display IAI.

There are two often used methods of supervisory control of UAVs: management by consent (MBC) and management by exception (MBE) [10]. MBC requires the automation to ask for an explicit consent from the human operator before taking any action; MBE, on the other hand, allows the automation to initiate/perform actions unless overruled by the human operator [11]. Olson and et al. have reported that an MBC-type decision aid provides the highest mission efficiency, resulting in the best survivability performance, and also

Situation Awareness (SA) is the highest in the MBC condition. Thus, we chose the MBC method for the supervisory control of UAVs.

The rest of this paper is arranged as what follows. In Section 2, an overview to related works has been provided. The proposed IAI based on our comprehensive architecture will be presented in detail in Section 3. The simulation results are reported in Section 4. Finally, conclusion has been drawn in Section 5.

## 2. Related works

As mentioned earlier, there are many works in the field of designing a user interface for controlling a swarm of UAVs but most of these works have not proposed an IAI. However, very important notes have been propounded in these works. Thus, a collection of them will be reviewed in this section. Situation Awareness is one of the most important issues in multi-UAV controlling. A fine-grained decomposition of situation awareness (SA) has been presented in [12]. In this paper, it can be noted that the human-UAV interaction awareness consists of the understanding that the human has from UAV's: 3D spatial relationship, predicted 3D spatial relationships, weather near UAV, health of the UAV, status of UAV, logic of UAV and UAV's mission, UAV's progress towards completing the mission, and degree to which UAV can be trusted. We tried to present most of these features in our IAI.

In [13], it has been stressed that the support UAV tasking and control should all be within a single display screen. Interacting with UAV using a single display interface has also been emphasized in [14]. In this article, the authors have stated that "the first task in improving the user interface was to put all the functionalities onto a single screen". Therefore, as shown in the following sections, we proposed all features of our IAI in a single display interface.

In [15], a Graphic User Interface (GUI) for monitoring multi-UAV missions and thermal columns has been developed. The most important functions of this GUI are modifying and consulting on-board parameters in flight, monitoring fly data in real-time, and easy adaptation for a multi-UAV mission with different numbers of UAVs. Thus, some important issues such as intelligent adaptation, delivering information based on user's mental expectations, and also security have been neglected in this GUI. Most of the previous works have introduced a very complex user interface for UAV controlling. For example, a complex interface for multi-UAV

controlling has been proposed in [16]. Authors of this paper have expressed that "human interactions with the system were complex". One of the most important reasons for this problem, aside from complexity of the nature of UAV controlling, is complexity of the proposed interface in this article. However, complexity of the user interface is a widespread problem in most proposed user interfaces in the field of controlling a group of UAVs.

Another complex user interface for UAV controlling has been presented in [17]. In addition, an appropriate user interface has been proposed in [18] but this interface has two main screens and also, to some extent, suffers from complexity. Thus, we decided to propose our IAI in a very simple and intuitive form, as much as possible.

It should be noted that a set of noteworthy recommendations that facilitates and supports design an intuitive interface for supervisory control of multiple UAVs has been proposed in [19]. We tried to consider all of these recommendations to propose a simple and intuitive IAI. Some of these recommendations are considering the user's mental expectations, and the need to distribute attention, data extraction, and redundancy. Finally, a comprehensive review on research pertaining to the limitations and advantages of supervisory control for unmanned systems has been proposed in [11] that is worth considering.

## 3. Proposed IAI architecture

For designing and implementing an IAI, first of all, an appropriate IAI architecture should be selected. For this reason, we designed and implemented our proposed IAI based on our proposed comprehensive IAI architecture. This architecture and its components at the first level are depicted in figure 1.

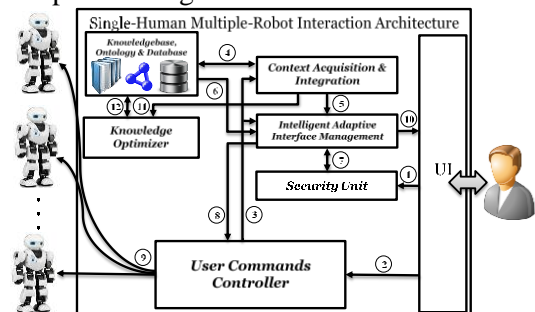

Figure 1. The proposed IAI Architecture for Single-Human Multiple-Robot Interaction.

The main units of the proposed architecture in figure 1 have several important sub-units. Context Acquisition & Integration sub-units are Situation

State Assessment (SSA) (that has five blocks: Mission Goal Monitoring, Activity Monitoring, Sensor Monitoring, Contextual Object Recognition, and Contextual Relationship Detection), User State Assessment (that has four blocks: Behavioral Monitoring, Psychophysiological Monitoring, User Model Estimation, and User Situation Awareness Monitoring), System State Assessment, Collaboration Monitoring, Context Integrator, and Context Manager.

Also, Intelligent Adaptive Interface Management has some significant sub-units: Analysis/Inference Engine, Explanation, Cognitive Assistance, Contingency Detector, State Information Summary Generator, User Interface Generation Manager, User Interface Generator, and Security Manager. Finally, Security Unit has two sub-units: Authentication, Authorization, and Accounting (AAA) Unit, and Cryptography Unit (Encryption/Decryption Unit and Steganography Unit).

Our proposed comprehensive architecture has many details and elaborations, which have been given in [12]. Indeed, our IAI configuration and interaction with the user are thoroughly formed based on the introduced IAI architecture. In the following, at first, an overall view of the proposed IAI will be described and then all of the remarked features of this IAI (in the introduction section) will be explained separately. An overall view of the proposed IAI is shown in figure 2.



**Figure 2. Overall view of the proposed IAI for three UAVs. The selected UAV has been highlighted in yellow and the waypoints of UAV No. 1 have been displayed in cyan.**

### 3.1. Special Features of Proposed IAI

The remarked features of the proposed IAI will be explained as follow, separately:

1. Providing very simple cryptography facilities:

It is made clear that the operator does not need to be exposed to the cryptographic details of the

system, by [13]. In our IAI, to send and receive secured data to and from UAV(s), the user will only need to do two clicks (one click for selecting Encryption or Steganography and one click on the Lock icon for starting cryptography). Thus, all the cryptographic details such as selecting cryptographic algorithm and key agreement are kept hidden from the user.

2. Supplying single and group modes to command to UAV(s):

In the proposed IAI, the user commands will only be sent to the selected UAV(s). Thus, when the user decides to send a group command, s/he just needs to select all UAVs (by one click) and then send command.

3. Temporal in-place UAV's camera displays and delivers information based on user's mental expectations:

In [11], the authors have stated that an appropriate user interface should deliver information based on the user's mental expectations. For example, when a contingency is detected by the contingency detector unit, then the user must be notified and also should be guided to manage this contingency. For tackling this significant problem, we proposed two solutions: temporal in-place UAV camera display and delivering information based on the user's mental expectations. The temporal in-place UAV camera display is a small window that displays UAV front camera Field of View (FOV) for a few seconds. This window is demonstrated just at the back of the UAV icon and moves along with it. Thus, when a collision is detected by Contingency Detector, this window will be displayed instantly.

The temporal in-place UAV camera display is one of the novelties of the proposed IAI. By this window, we can overcome some challenges like guiding the user's attention to the right UAV(s) at the right time, least changes in the user's eye gaze during tracking a contingency, managing multi-simultaneously occurring contingencies for different UAVs, delivering concise and usable in-place information about contingency (like remaining distance to the obstacle), and realizing the single display user interface for UAV team controlling.

Figure 3 illustrates two temporal in-place UAV camera displays when two collisions to wind turbines have been detected simultaneously. For delivering a concise and usable in-place information about these collisions, the remaining distance to the wind turbines is shown at the

bottom of these windows in meters.



**Fig. 3. Two simultaneously occurring collisions and their accordant temporal in-place UAV camera displays at the back of the UAV icons.**

Delivering information based on the user’s mental expectations is another solution that we offered to assist the user when contingencies occur. For example, when a collision is detected by the Contingency Detector, it can be shown as an arrow to the user to avoid the reported collision. Therefore, in our proposed IAI, the best direction for avoiding collisions is inferred and is then displayed using a green arrow at the front of the appropriate UAVs. This arrow is depicted in front of two UAVs in figure 3.

4. Temporal in-place user guideline:

One of the most important capabilities of IAIs is to provide a decision support for the user based on the current situation of the context. This important issue has been considered in [14]. In this paper, it has been noted that the controller should present data relevant to the operation in a way that does not force operators to rely on a long-term memory. Additionally, the design should avoid requiring any unnecessary cognitive work like mental calculations.

Thus, we decided to design and implement a new process to support the user to avoid requiring any unnecessary rely on the long-term memory and cognitive works. In [14], it has been noted that the battery life of the system is not as important as the expected range. Thus, by notifying the expected range instead of sticking to display only UAV battery life, several mental calculations would be removed. Thereupon, reducing the amount of time and work, it takes for the operator to determine if they should end the flight (or operation) to avoid an accident. Thus, we decided to design our process based on this reality.

Finally, we proposed a new intelligent notification process that alerts the user when the battery life is not enough to continue the UAV operation. This notification has been inferred based on four

basic parameters: Battery Life, Remaining Distance (until the end of the operation), UAV Speed, and Wind Speed. For inference based on these four parameters, we chose the fuzzy inference system.

Afterwards, three linguistic variables (Low, Moderate, and High) with Gaussian membership functions were assigned to fuzzify the four mentioned parameters. Then 81 fuzzy rules were defined to response to this question that “is it possible to continue operation or not?” One of these rules is:

IF Battery\_Life IS Moderate AND Remaining\_Distance IS High AND UAV\_Speed IS Moderate AND Wind\_Speed IS High, THEN Continuing\_To\_Operation IS Impossible

At first, the Mamdani type of fuzzy inference system was chosen as the inference method. Then we tested our proposed system by a simulated test set that contained 307 samples (each sample contains values for four variables: Battery Life, Remaining Distance, UAV Speed, and Wind Speed in a specific moment of a simulated operation). The results obtained showed that the final precision of fuzzy inference system was equal to 95.57%. To reach a more precise inference, we utilized our proposed enhanced fuzzy inference system based on mutual information [15] in this problem.

In our enhanced fuzzy inference system, first of all, the mutual information between all linguistic variables of the four mentioned parameters and two output classes (Continue\_To\_Operation: Possible or Impossible) must be calculated. Eventually, the enhanced fuzzy inference was applied to the problem after completion of the prerequisites. The results obtained showed that the precision of the enhanced fuzzy inference system was equal to 98.03%.

Thereafter, determining that a given UAV cannot continue its operation, the user must be notified about this incident. Thus, we designed a new mechanism to inform the user about this occurrence, which was named “temporal in-place user guideline”. In this mechanism, a temporal small window is displayed just at the back of the given UAVs' (that cannot continue their operations) icon. In this window, the user is informed about the inability to continue the operation. Figure 4 illustrates this window.



**Fig. 4. Temporal in-place user guideline window that has been displayed when a given UAV (UAV No. 1) has not been able to continue its operation.**

As shown in figure 4, there is a button at the bottom of the temporal in-place user guideline window. This button enables the user to issue the “Back to the Base” command to the UAV as easy as possible. Of course, it is possible that the user does not issue any command and accepting this risk about the UAV is going to fall to the ground!

**5. Quick show concise explanation of system behavior:**

As described above, when it was inferred that a given UAV could not continue its operation, a temporal in-place notification window would be displayed to the user. Now a method should be provided to explain the reasons that have led to this decision to the user.

Thus, in our proposed IAI, if the user wants to be informed about the reasons for the inability to continue operation, s/he just needs to click on the temporal in-place notification window except its buttons. Then a concise explanation of the system behavior is displayed at the bottom of the main window. This concise explanation is shown in figure 5.

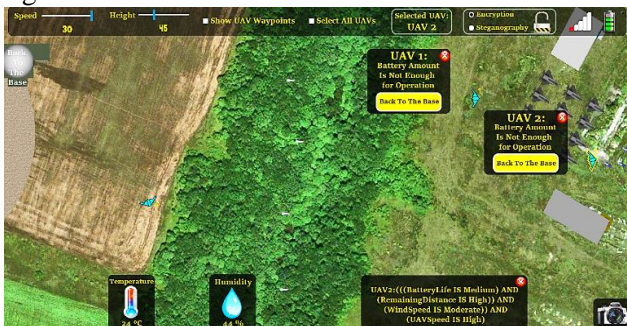

**Fig. 5. Quick show concise explanation of system behavior, which is displayed at the bottom of the main window when the user wants to know the reason for the system decision. In this figure, the user has clicked on the temporal in-place notification window of UAV No. 2.**

As illustrated in figure 5, due to the values of UAV's Battery-Life, Remaining-Distance, Wind-Speed, and UAV-Speed, it has been inferred

that the UAV No. 2's Battery-Life is not sufficient to continue its operation.

**6. Providing multi-modal interaction:**

As mentioned earlier, the temporal in-place user guideline and the temporal in-place UAV camera display windows are displayed to the user when s/he needs them. However, it is very important to guide the user's attention to these windows very quickly. Thus, when these windows are displayed, appropriate notification sounds are also played simultaneously. These short notification sound clips have been selected exactly proper to the related windows. As a result, the user can detect which windows have been displayed even without looking at them and only by hearing these sound notifications.

**7. UAV icon luminance adaptation:**

It is a very serious challenge that which color we should choose for the UAV's icon. For example, the aerial spraying crops or flower farms is one of the applications of the UAVs, and in this application, the mentioned challenge is more evident. One of the solutions to overcome this problem is to change the UAV icon color based on the current background of the UAV adaptively. However, this solution is very boring and undesirable for the user. Thus, we decided to change the luminance of the UAVs' icons based on the current backgrounds of the UAVs.

In a significant research work in [16], it has been found that the visual search times, number of eye fixations, and mean fixation durations increased strongly with decreasing luminance contrast despite the presence of color contrast. Thus, adaptively changing luminance of the UAVs' icons is a very effective way to conquer the mentioned challenge.

Thereupon, we defined 25 fuzzy rules to infer appropriate luminance for each one of the UAVs' icons based on their current backgrounds. Then luminance of the UAV icon is changed every 0.5 s during the operation, and will be immediately applied to the UAV icon. Different luminances of UAVs' icons that inferred based on their local background's luminance are shown in figure 6.



**Figure 6. Different luminance of the UAVs' icons that inferred by fuzzy inference based on their local background luminance. Each one of the UAV icons has been highlighted in dashed red square.**

8. Delivering information based on the user forgetting model:

One of the most notable contributions of our proposed IAI is delivering information based on the user forgetting model. To reach this aim, first of all, the user forgetting should be modeled using a suitable forgetting theory. To model the user forgetting, it should be used as a proper human cognitive architecture. Thus, we selected ACT-R (Adaptive Control of Thought-Rational) [17] as a unified theory of cognition that aims to explain the full range of human cognition [18].

Since the standard ACT-R architecture has a poor mechanism for modeling forgetting, we used our enhanced version of ACT-R, which was equipped with the SIMPLE (Scale-Invariant Memory, Perception, and Learning) forgetting model. In this expansion of ACT-R, we equipped standard ACT-R with SIMPLE forgetting model for modeling forgetting in short-term memory based on the time and capacity of the short-term memory.

Afterwards, we defined a scenario to test our proposed algorithm to display information based on the user forgetting model. In this scenario, we delivered a package of information about weather conditions that should be known by the user during the operation before starting it. This package contains information about conditions of Weather, Precipitation, Temperature, Fog, Humidity, Wind Speed, and Wind Direction. Displaying this package of information before starting the operation is depicted in figure 7.



**Figure 7. Package of information about weather conditions, displayed before starting the operation.**

It was pointed out to the users that they should remember this information in 14 s (each item of information is displayed every 2 s). Then it can be assumed that the items in the weather conditions package have been memorized in the user short-term memory. Thus, this information is passed to ACT-R, respectively, to their display time. Then during the operation, every 2 s, it is checked whether each one of this information has a retrieval probability below 0.55. This retrieval probability is calculated by the SIMPLE forgetting model, and when this value is below 0.55, it means that the user is forgetting the specific item of the memorized information.

Finally, when each one of the items of information pack (that exists in the short-term memory) has a retrieval probability below 0.55, then this piece of information is displayed to the user instantly with an appropriate notification sound. Afterward, this displayed item of information will be retrieved in the SIMPLE forgetting model as a chunk of information. As a result, the retrieval probability of this item will return to 1. An example for delivering information based on the user forgetting model is shown in figure 8.

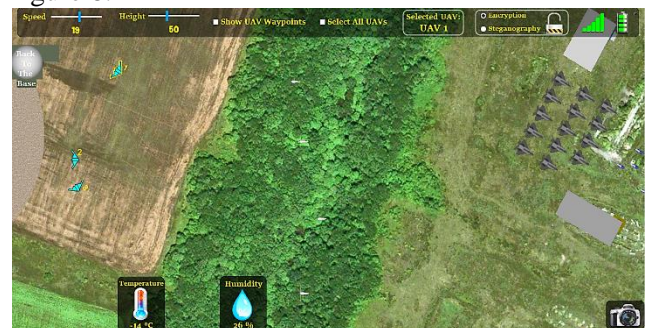

**Figure 8. Delivering information based on the user forgetting model. Temperature and Humidity have been displayed to the user based on SIMPLE forgetting the model at a given time meanwhile an operation.**

#### 4. Implementation and Results

Now the main question is whether the proposed IAI architecture can improve the efficiency measurements in a real operation or not? To answer this question, we implemented an IAI based on our proposed architecture to control a group of UAVs. To evaluate IAI, different simulated scenarios were used by eleven contributors. Each one of the contributors completed the operations in two modes: IAI on and IAI off.

In the IAI on mode, the features such as intelligent warning to avoid collision, display important information based on the user cognitive and forgetting model, and intelligent warning for inability to continue operations were enabled. In the IAI off mode, the IAI features were disabled (that is named Classic Interface).

To test the proposed IAI in different levels of workload, we designed three scenarios, as follow:

1. Reconnaissance operation with three UAVs, which is called the "3 UAVs" operation.
2. Reconnaissance operation with five UAVs, which is called the "5 UAVs" operation.
3. Reconnaissance operation with five UAVs and with compulsion to cryptography in a specific situation, meanwhile the operation that is called "5 UAVs with Encryption" operation.

To evaluate each operation, the objective and subjective measures were considered as follow:

1. Objective measures:
  - a. Situation Awareness Global Assessment Technique (SAGAT), proposed in [19].
  - b. Mission completion percentage.
2. Subjective measures:
  - a. NASA Task Load Index (NASA-TLX), proposed in [20].
  - b. Overall perceived Situation Awareness (SA) assessment using 7-Point Likert-Type Scale (from Very-Low or 1 to Very-High or 7) questionnaire.

Note that all of the four mentioned measures are standard and have been widely reported in the literature.

As mentioned earlier, we designed three operation scenarios, and each contributor completed the operations in two modes (IAI on and IAI off). Finally, all information about the objective and subjective measures was gathered for every six operations and for each contributor. A statistical

comparison between the results obtained for SAGAT score that has been made by the box and whiskers diagrams is shown in figure 9.

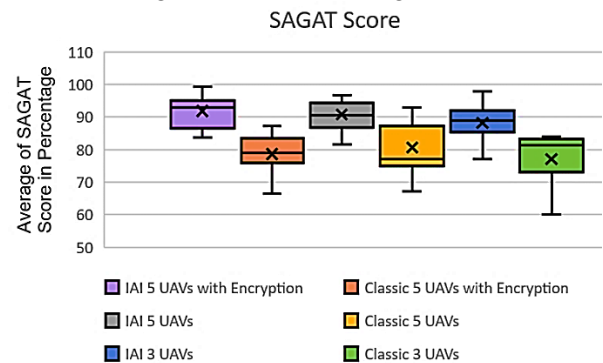

**Figure 9. Box and whiskers diagrams for SAGAT score. Operations that were completed using the interface that had intelligent features were named as IAI, and otherwise, were called Classic.**

As shown in figure 9, it is obvious that the average SAGAT score in operations, which have been done using IAI (that has been represented by X in the box) is clearly greater than the operations that have been completed by Classic interface. It shows that the user's Situation Awareness level can be improved using the proposed IAI based on our architecture. The second objective measures for comparing IAI and Classic interface is mission completion percentage. Figure 10 shows a comparison between the statistical results for the mission completion percentages for all operations.

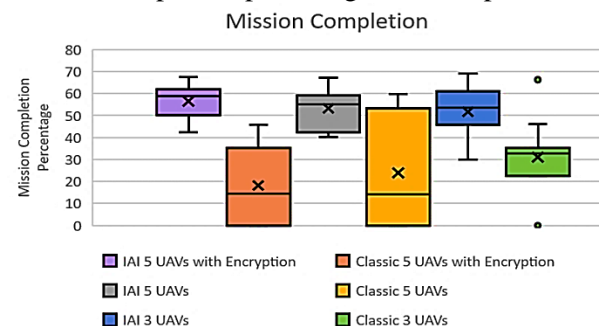

**Figure 10. Box and whiskers diagrams for the mission completion percentage.**

As depicted in figure 10, the average mission completion for operations that have been done using IAI is significantly above the operations that have been completed by Classic interface. Note that the operations' scenarios were designed in such a way that the contributors had to cancel reconnaissance operation (in the middle of the operation) for safely bringing UAVs to the base. Thus, the maximum value for operation completion percentage is about 70%, and therefore, 50% mission completion is a good



operation completion percentage. NASA-TLX and Overall Perceived SA were selected as the subjective measures for gauging cognitive workload and perceived situation awareness, respectively. The results obtained for these subjective measures are illustrated in Figs. 11 and 12.

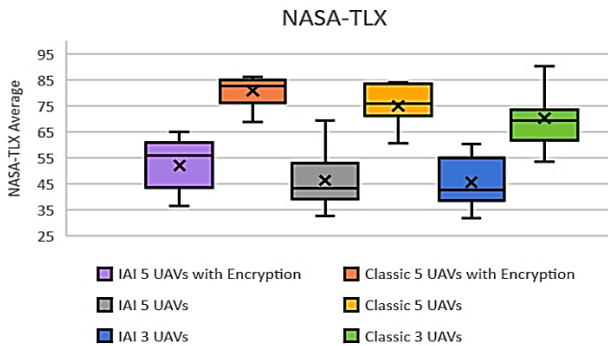

Figure 11. Box and whiskers diagrams for the NASA Task Load Index (NASA-TLX).

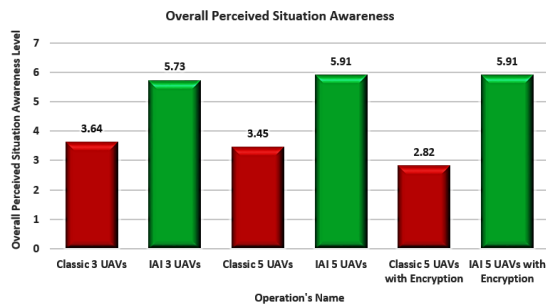

Figure 12. Comparison between averages of Overall Perceived Situation Awareness Level calculated for all six operations.

According to figure 11, the average value of NASA-TLX for Classic interfaces are significantly greater than the IAI ones. It shows that more workload was imposed on the contributors when they were doing the operations using Classic interface. It should be noted that the highest value of the NASA-TLX is equal \*to 100, which shows the highest workload on the user. Also, as shown in figure 12, all users stated that the Overall Perceived Situation Awareness was remarkably greater in operations that had been done using IAI than the operations that had been completed by Classic interface.

One of the most important advantages of IAI is reducing the user's workload and simultaneously increasing the user's situation awareness. The results obtained for evaluating the users' Situation Awareness that are shown in figures 9 and 12 and also the results for assessment of the users' workload that are depicted in figure 11 prove the fact that we simultaneously reduce the user's

workload and increase the user's situation awareness using the proposed IAI based on our architecture. Furthermore, for a simultaneous comparison, we compared the users' Situation Awareness that has been calculated by SAGAT score and the users' workload that has been obtained by NASA-TLX for all the six operations. Figure 13 demonstrates this comparison.

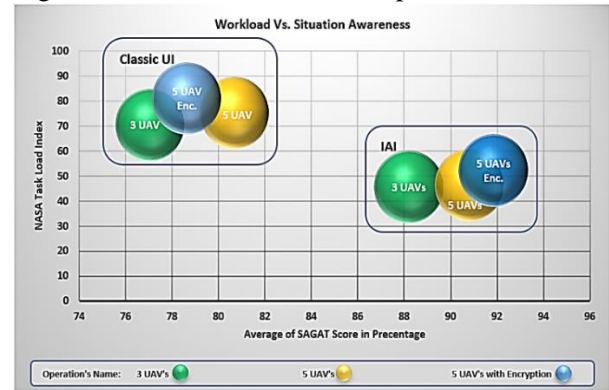

Figure 13. Reducing workload and simultaneously increasing situation awareness for all operations that have been done using IAI against Classic User Interface. All operations that have been done using IAI have a greater value for SAGAT score and also have a less value for NASA-TLX than operations that have been completed using Classic UI.

As previously emphasized, one of the most important goals of IAIs is to reduce the user's workload to reach the desirable and efficient interaction, which finally leads to an increasing operation completion percentage. Figure 14 proves that we could decrease the user's workload and simultaneously increase the mission completion percentage in all operations.

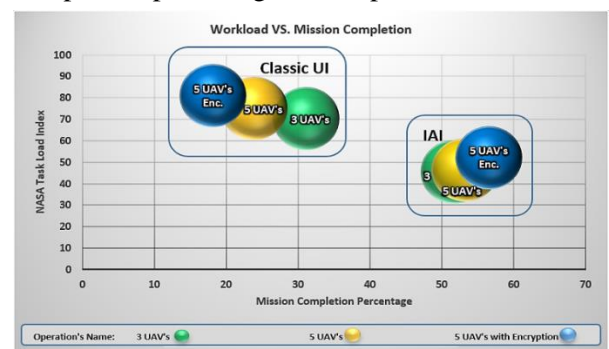

Figure 14. Decreasing user's workload that leads to increasing mission completion percentage for all operations that have been done using IAI against Classic User Interface.

At the end of this section, it must be noted that we cannot compare our results with any of the previous works due to two main reasons:

1. Each one of the previous works used its

own custom scenarios without mentioning the details. Thus, we could not simulate the same scenarios with the same workload as the previous works' scenarios.

- Not only there are no standard scenarios for testing intelligent adaptive interfaces in the field of multi-UAV controlling but also each one of the previous works tested its proposed IAI with different criteria and measures.

Nevertheless, for a better understanding, we decided to compare our results with somewhat

similar experiments. To do this, given the reasons for not being able to compare precisely, we considered percentage increase for the situation awareness level and percentage decrease for the user workload. It means that we compare two works using reported percentage increase for SAGAT and reported percentage decrease for NASA-TLX. Note that all these experiments presented adaptive or intelligent interface (console) to control a group of unmanned vehicles. Some concise descriptions for these experiments are shown in Table 1.

**Table 1. Brief introduction to some similar experiments.**

| Experiment Reference Number | Number of under-command unmanned vehicles | Concise Description   |
|-----------------------------|---|---|
| [21]                        | 5   | SAGAT and NASA-TLX have been calculated in different scenarios and in two modes: IAI On and IAI Off   |
| [22]                        | 4   | Cognitive Workload (CW) and Situation Awareness (SA) have been evaluated by NASA-TLX and SAGAT in a Transparent Autonomy Interface  |
| [23]                        | 3   | A comparison has been made between CI (Conventional Interface) and PCI (Predictive Conventional Interface) and PVRI (Predictive Virtual Reality Interface) using NASA-TLX and SAGAT |
| [24]                        | 4   | Adaptive console for supervisory control of multiple UAVs has been evaluated by NASA-TLX and SAGAT  |
| [25]                        | 4   | NASA-TLX and SAGAT have been used to evaluate a cognitive and cooperative assistant system for aerial manned-unmanned teaming missions  |

As mentioned in Table 1, all of these experiments have used SAGAT score to evaluate situation awareness level and NASA-TLX to assess the user workload. A comparison between our percentage increase for SAGAT and reported results of mentioned works for SAGAT percentage increase has been made in figure 15.

results have been reported in a scenario for controlling 5 UAVs. Nevertheless, by this comparison, it is clear that our reported results for situation awareness increase rate are very suitable and significant.

Furthermore, we compared our percentage decrease for NASA-TLX with reported percentage decrease of the mentioned experiments. This comparison is illustrated in figure 16.

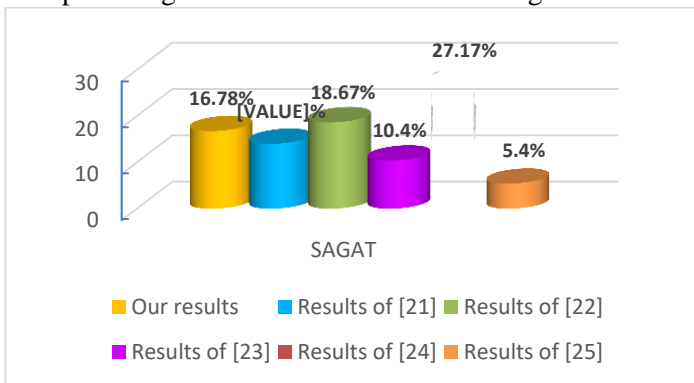

**Figure 15. A comparison between SAGAT percentage increase in our results and reported results in somewhat similar experiments.**

As shown in figure 15, the results in [22] and [24] show a greater SAGAT score than our results. However, it should be noted that the results in [22] and [24] have been reported in a scenario for controlling 4 UAVs despite the fact that our

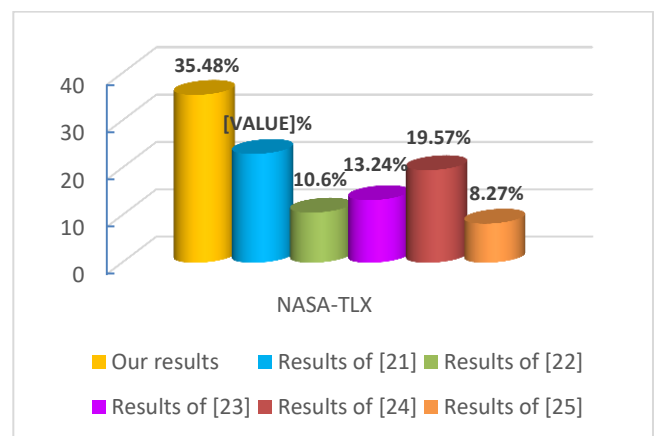

**Figure 16. A comparison between NASA-TLX percentage decrease in our results and reported results in somewhat similar experiments.**

As illustrated in figure 16, it is obvious that our percentage decrease for NASA-TLX is significantly greater than the reported percentages decrease for NASA-TLX in the mentioned works. This means that we could significantly decrease the workload of the users even in more complex operations than the reported ones.

Finally, for a simultaneous comparison between the reported results for SAGAT and NASA-TLX and also determining position of our results among other reported results, figure 17 is presented.

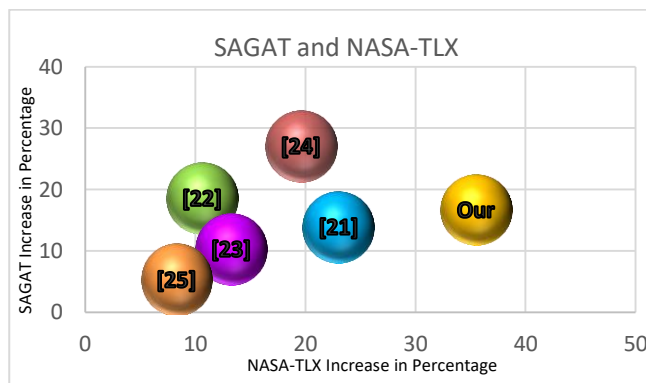

Figure 17. Simultaneous comparison between reported results for SAGAT and NASA-TLX.

As depicted in figure 17, our results have a good balance in increasing SAGAT and decreasing NASA-TLX. Furthermore, in [21], it has been reported that Perceived SA for controlling five UAVs is equal to 5.3. Our result for this score for controlling five UAVs is equal to 5.91. Thereupon, these comparisons indicate that, apart from the fact that our IAI yields good results, on the other hand, the range of our results are also in a reasonable range reported in the literature.

### 5. Conclusion and Future Works

In this paper, we have proposed a novel intelligent adaptive interface for controlling a group of UAVs by a single user. The proposed IAI has some brilliant new features such as:

- Delivering information based on the user’s mental expectations
- Quick show concise explanation of system behavior
- Providing very simple cryptography facilities
  - Temporal in-place UAV camera display
  - Providing single display IAI for controlling multi-UAVs
- Temporal in-place user guideline
- Intelligent adaptation of UAVs' icon

luminance

- Providing multi-modal interaction

The main objectives of designing such intelligent adaptive interfaces are to reduce the user's workload, to increase the user's situation awareness, and finally, to increase the mission completion percentage. Thus, we decided to test our proposed IAI in different simulated scenarios. Therefore, we defined three operation scenarios that had to be done in two modes: IAI on and IAI off.

Afterwards, each one of these operations were completed by eleven contributors. The results obtained showed that the proposed IAI based on our architecture could increase the users' situation awareness and also could decrease the users' workload, and finally, led to promote the mission completion percentage. As a result, we achieved all our goals for designing and implementation of our IAI.

As mentioned in the introduction section, our proposed IAI is based upon our comprehensive IAI architecture. Our architecture has ten important aspects that the proposed IAI realized, as follow:

1. By some features of IAI such as delivering information based on the user’s mental expectations, intelligent adaptation of UAVs' icons luminance, and delivering information based on the user forgetting model, adaptation to interaction context changes was achieved.
2. By delivering information based on the user forgetting model and delivering information of important occurring events in the context (like wind speed change), delivering the right information at the right time to the user was achieved.
3. By providing very simple cryptography facilities, performing secure interaction with the lowest level of user intervention was achieved.
4. By a quick show concise explanation of the system behavior and using temporal in-place user guideline, supporting user by cognitive assistance and system behavior explanation was achieved.
5. By utilizing our proposed enhanced fuzzy inference system based on mutual information, which can improve precision of the inference system based on user feedbacks and boosting fuzzy rules weights, self-optimization for the proposed

architecture to update its knowledgebase over time was achieved.

6. By checking the security of each command issued by the user as well as delivering information to the user after security checks, continuous/active authentication was achieved.
7. By delivering information based on the user forgetting model, considering the user forgetting model for delivering information to him/her was achieved.

It must be noted that the two features 1. Using ontology for modeling knowledge and 2. Proposing a method to detect new concepts and relationships, have not been considered in this prototype of the IAI architecture. Also, the last remaining aspect that is considering inter-relationship and collaboration of robots in the interaction process does not matter in our test scenarios.

In the future, we should improve our proposed IAI using the followings:

- Promoting user state assessment by employing new methods and algorithms for:
  - User behavioral monitoring
  - User psycho-physiological monitoring
  - User model estimation
  - Situation awareness monitoring
- Engaging different powerful inferencing and reasoning methods and ensemble results of these methods to reach quite accurate inferencing.
- Intelligent user feedback gathering for knowledge optimization and promoting intelligent behavior of IAI.
- Proposing new and efficient state information summary generator.

Presenting novel methods for user decision supporting and user cognitive assistance.

## References

- [1] Bethke, B., How, J. P. & Vian, J. (2008). Group health management of UAV teams with applications to persistent surveillance, in Proceedings of the American Control Conference, pp. 3145–3150.
- [2] Perez, D., Maza, I., Caballero, F., Scarlatti, D., Casado, E. & Ollero, A. (2013). A ground control station for a Multi-UAV surveillance system: Design and validation in field experiments, *J. Intell. Robot. Syst. Theory Appl.*, vol. 69, no. 1–4, pp. 119–130.
- [3] Hou, M., Zhu, H., Zhou, M. & Arrabito, R. (2015). Advances and Challenges in Intelligent Adaptive Interface Design,” *Human–Machine Syst. Des.*, pp. 369–424.
- [4] Fortmann F. & Lüdtke, A. (2013). An intelligent SA-adaptive interface to aid supervisory control of a UAV swarm, in *IEEE International Conference on Industrial Informatics (INDIN)*, pp. 768–773.
- [5] Hanumansetty, R. G. (2004). Model based approach for context aware and adaptive user interface generation.
- [6] Donath, D., Rauschert, A. & Schulte, A. (2010). Cognitive assistant system concept for multi-UAV guidance using human operator behaviour models, *Humous’10*.
- [7] Tahmasebi, M. et al., (2018). Hybrid Adaptive Educational Hypermedia Recommender Accommodating User’s Learning Style and Web Page Features, *J. AI Data Min.*
- [8] Arrabito, G. R. et al., (2010). Human Factors Issues for Controlling Uninhabited Aerial Vehicles, no. November.
- [9] Brown, G. D. A., Neath, I. & Chater, N. (2007). A temporal ratio model of memory, *Psychol. Rev.*, vol. 114, no. 3, pp. 539–576.
- [10] Olson W. A. & Sarter, N. B. (2001). Management by consent in human-machine systems: when and why it breaks down, *Hum. Factors*, vol. 43, no. 2, pp. 255–266.
- [11] Chen, J. Y. C., Barnes, M. J. & Harper-Sciarini, M. (2011). Supervisory control of multiple robots: Human-performance issues and user-interface design, *IEEE Trans. Syst. Man Cybern. Part C Appl. Rev.*, vol. 41, no. 4, pp. 435–454.
- [12] Ilbeygi M. & Kangavari, M. R. (2018). Comprehensive architecture for intelligent adaptive interface in the field of single-human multiple-robot interaction, *ETRI J.*, vol. 40, no. 4, pp. 483–498.
- [13] Petcher, A., Khazan, R. & Utin, D. (2011). A usable interface for location-based access control and Over-The-Air Keying in tactical environments,” in *Proceedings - IEEE Military Communications Conference MILCOM*, pp. 1480–1486.
- [14] Jimenez, F., Faerevaag, C., & Jentsch, C. L. (2016). User Interface Design Recommendations for Small Unmanned Aircraft Systems (sUAS), *Int. J. Aviat. Aeronaut. Aerosp.*, vol. 3, no. 2.
- [15] Ilbeygi, M. & Kangavari, M. R. (2017). An Improvement in Fuzzy Inference System for Classification Problems Using Mutual Information, in *The 4th International Conference on Electrical Engineering, Computer Science and Information Technology*.
- [16] Ojanpää, H. & Näsänen, R. (2003). Effects of luminance and colour contrast on the search of

information on display devices, *Displays*, vol. 24, no. 4–5, pp. 167–178.

[17] Anderson, J. R., Bothell, D., Byrne, M. D., Douglass, S., Lebiere, C. & Qin, Y. (2004). An integrated theory of the mind, *Psychol. Rev.*, vol. 111, no. 4, pp. 1036–60.

[18] Ritter, S., Anderson, J. R., Koedinger, K. R. & Corbett, A. (2007). Cognitive tutor: applied research in mathematics education, *Psychon Bull Rev*, vol. 14, no. 2, pp. 249–255.

[19] Endsley, M. R. (1995). Toward a Theory of Situation Awareness in Dynamic Systems, *Hum. Factors J. Hum. Factors Ergon. Soc.*, vol. 37, no. 1, pp. 32–64.

[20] Hart, S. G. (2006). NASA-task load index (NASA-TLX); 20 years later, *Hum. Factors Ergon. Soc. Annu. Meeting*, pp. 904–908.

[21] Hou, M. & Kobierski, R. D. (2006). Intelligent Adaptive Interfaces: Summary Report on Design, Development, and Evaluation of Intelligent Adaptive Interfaces for the Control of Multiple UAVs from an Airborne Platform.

[22] Chen, T. (2016). Management of multiple heterogeneous unmanned aerial vehicles through transparency capability, *Télécom Bretagne; Université de Bretagne Occidentale*.

[23] Roldán, J. J., Peña-Tapia, E., Martin-Barrio, M. A. Olivares-Méndez, Del Cerro, J. & Barrientos, A. (2017). Multi-robot interfaces and operator situational awareness: Study of the impact of immersion and prediction, *Sensors*, vol. 17, no. 8, p. 1720.

[24] Fuchs, C. , Ferreira, S., Sousa, J. & Gonçalves, G. (2013). Adaptive Consoles for Supervisory Control of Multiple Unmanned Aerial Vehicles, in *Human-Computer Interaction. Interaction Modalities and Techniques*, vol. 8007, pp. 678–687.

[25] Rauschert, A. & Schulte, A. (2012). Cognitive and cooperative assistant system for aerial manned-unmanned teaming missions, *NATO Res. Technol. Agency, Hum. Factors Med. Panel, Task Gr. HFM-170 Superv. Control Mult. Uninhabited Syst. Methodol. Enabling Oper. Interface Technol. RTO-TR-HFM*, vol. 170, pp. 1–16.

## ارائه یک رابط کاربری تطبیقی هوشمند تک صفحه‌ای به منظور کنترل گروهی از پهپادها

مهدی ایل بیگی\* و محمدرضا کنگاوری

دانشگاه علم و صنعت، تهران، ایران.

ارسال ۲۰۱۸/۰۴/۱۸؛ بازنگری ۲۰۱۸/۱۲/۲۹؛ پذیرش ۲۰۱۹/۰۱/۲۳

### چکیده:

کاربرد روزافزون پهپادها در عملیات‌های مختلف نظامی و غیرنظامی، توجه فراوان محققان و مؤسسات تحقیقاتی را به خود جلب کرده است. یکی از مهمترین چالش‌ها در این زمینه، کنترل گروهی از پهپادها توسط یک کاربر انسانی می‌باشد. در نتیجه در این مقاله ما یک رابط کاربری تطبیقی هوشمند برای فائق آمدن بر این چالش ارائه داده‌ایم. این رابط کاربری علاوه بر اینکه بر اساس یک معماری جامع برای تعامل یک کاربر با چندین ربات به شیوه تطبیقی هوشمند ارائه شده است، دارای ویژگی‌های منحصر به فردی نیز است، مانند: ارائه رابط کاربری تک صفحه‌ای برای کنترل گروهی از پهپادها، ارائه اطلاعات درست در زمان درست بر اساس مدل شناختی کاربر، پشتیبانی از کاربر با ارائه توضیح درباره رفتارهای سامانه، و کمک و راهنمایی کاربر برای اتخاذ تصمیم‌های درست. در نهایت رابط کاربری تطبیقی هوشمند ارائه شده با کمک یازده داوطلب و در سه سناریو مختلف آزمایش گردید. نتایج بدست آمده نمایانگر قدرت رابط کاربری ارائه شده در کاهش بار کاری کاربران و افزایش سطح آگاهی از وضعیت آن‌ها و در نهایت افزایش درصد تکمیل عملیات، بود.

**کلمات کلیدی:** رابط کاربری تطبیقی هوشمند، پهپاد، رابط کاربری تک صفحه‌ای، آگاهی از وضعیت، مدل شناختی، مدل فراموشی.