



Stability analysis of slope of a pump house building and water storage tank at Narkanda, India: A case study

Sahil Kumar* and Ravi Kumar Sharma

Department of Civil Engineering, NIT Hamirpur (HP), India

Article Info

Received 5 February 2024

Received in Revised form 16 February 2024

Accepted 3 June 2024

Published online 3 June 2024

DOI: [10.22044/jme.2024.14159.2634](https://doi.org/10.22044/jme.2024.14159.2634)

Keywords

Slope stability

Static and dynamic stability

Factor of safety

GEO5

Abstract

Slope stability analysis is essential in civil engineering, assessing slopes in various applications like dams, embankments, excavated slopes, and natural slopes. Techniques for slope stability analysis include limit equilibrium methods, empirical approaches for rock slopes, and finite element or finite difference methods. The present study is to conduct the stability analysis of slope which damaged the storage tank and pump house building of Jal Shakti Vibhag at Madhuban (Narkanda) Shimla, Himachal Pradesh using limit equilibrium method (LEM) and finite element method (FEM) and suggest appropriate mitigation measures. In this study slope is analyzed in natural state, and after application of proposed mitigation measures using self-driving anchor (SDA) or/and RCC micro piles analyzed for both static and dynamic conditions under dry and wet conditions. The values of FOS obtained by LEM in natural state under static dry and saturated conditions are 1.41 and 0.875 and dynamic saturated conditions are 0.95; the FOS obtained after applying mitigation measures SDA installing at an angle of $\theta = 10^\circ$ is 1.45. The values of FOS obtained from FEM analysis in natural state under static dry and saturated conditions are 1.52 and 0.98; dynamic saturated conditions are and 0.55. FOS obtained using combination of SDA and RCC micro piles and under static dry and saturated conditions are 2.75 and 2.23 and using dynamic analysis under dry and saturated conditions are 2.00 and 1.60.

1. Introduction

Man-made and natural landslides in steep areas represent a considerable threat to both engineers and society. They have a major influence on all creatures' habitats, resulting in substantial loss of life and property. Landslides occur annually in Himachal Pradesh mountainous regions during the monsoon season as a result of urbanization, climatic and topographical changes, and excessive rainfall. Consequently, excessive rainfall occurs in the region, thus creating a large number of landslide prone zones. The present study is to conduct the stability analysis of slope which damaged the storage tank and Pump house building of JSV (Jal Shakti Vibhag) at Madhuban (Narkanda) District Shimla Himachal Pradesh using Limit equilibrium method (LEM), finite element method (FEM), GEO5 software and suggest some mitigation of measures. A section of slope has washed away and lead to damage of Jal

Shakti Vibhag pump house building and water storage tank that are built over the slope. Damaged slope leads to the development of cracks through the water storage tank and pump house building at different locations as shown in Figure 2, Figure 3 and Figure 4. Telltales are installed over the cracks of machine foundation and displacement of crack is noted before and after as shown in Figure 6. To address excessive infiltration from constant rainfall, the project attempts to prevent slope failure in Shimla's Madhuban region by using SDA's and RCC cast in situ micro pile with stainless steel casing as a slope stabilization approach instead of other measures such as retaining walls, conventional soil nails, rock bolting, and anchors [0]. Soil anchors and micro piles have proved to be a successful effective solution for landslide

✉ Corresponding author: ksahilkumar596@gmail.com (S. Kumar)

mitigation [2-3]. However instead of conventional soil anchoring technique, SDA (self-driving anchors) and RCC (reinforced concrete cement) micro pile with stainless steel casing are employed for Madhuban slope landslide mitigation. SDAs are advanced hollow steel tube rods with a sacrificial drill bit and coupler for drilling. They are placed in the center of a drill hole using a centralizer, and protected by grout. SDAs have more bending strength and circumference area than solid steel bars, making them ideal for reinforcing solid bars, soil nails, and rock anchors. Installation can be done by a small drilling machine, providing slope protection in difficult access areas. RCC piles transfer structure load to deeper soil or rock stratum, while steel casing stabilizes borehole walls and addresses cave slurry leakage. Many researchers recommend using the finite element method (FEM) to understand deformation behavior. GEO5, a FE-based code, simulates the geometry of Madhuban landslide and predicts long-term behavior of reinforced structures. GEO5 is used for comprehensive study of soil nail structure, factor of safety (FOS), and failure surface [0-0].

In this research work, SDAs and cast in situ RCC steel casing micro piles are used to restore the failed slope. The paper evaluates the safety and slope deformation factors of both unreinforced and reinforced landslide slopes. The

safety factor is determined using the limit equilibrium method (LEM) and finite element method (FEM) using GEO5, which are validated through FEM analysis to evaluate the feasibility of rectified SDA and RCC micro pile slope [0-0] [0-0]. The methodology used in this research paper is Geotechnical assessment of soil, FEM analysis of stability of soil, remedies for stability of slope, and support system recommendations.

2. Study Area

The study examines a landslide that occurred near Madhuban village in Shimla District, Himachal Pradesh, India, which is 415 km from New Delhi and 71km from the capital Shimla. This place is located 300 km from Dharamshala, the winter capital and the wettest region in Himachal Pradesh. Narkanda is a town and nagar panchayat in Shimla district, Himachal Pradesh, located at an altitude of 1881 meters on the Hindustan-Tibet Road (NH 22) and with geocoordinates of 31° 19' 23.00" N and 77° 30' 06.00" E as shown in Figure 1.

Geologically, the area has loamy sand to sandy loam with varying percentage of gravels and light to dark yellowish-brown soil, the area is highly susceptible to landslides due to the weak soils that are subjected to thrust displacement. (b)

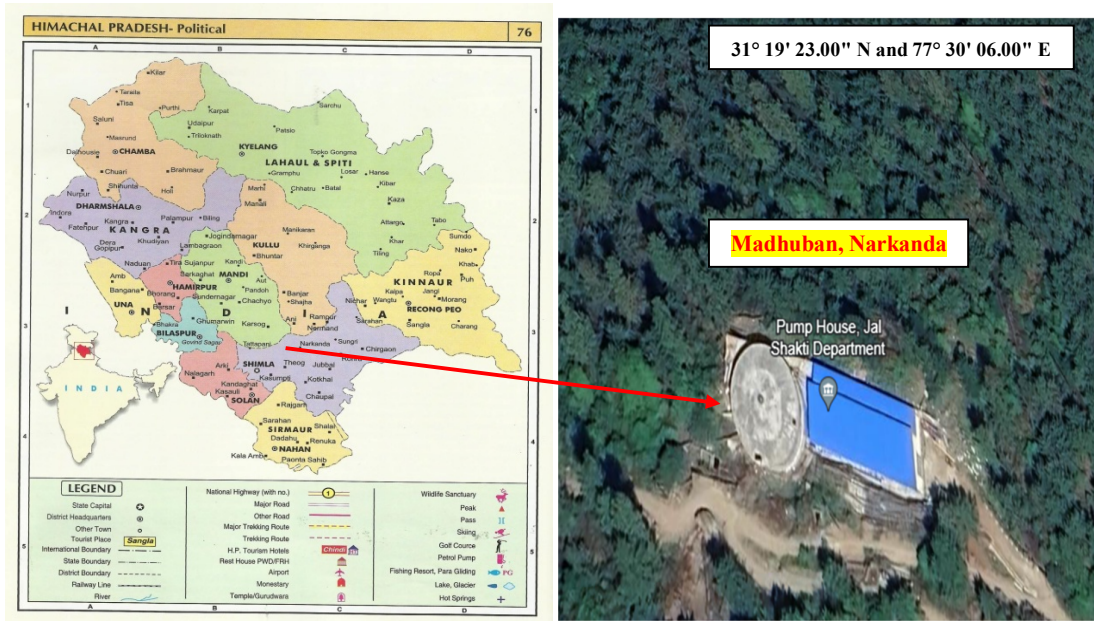

Figure 1. a) Map of study Area, b) Topographical view of study area

3. Landslide Classification

Landslides can be classified into various types, such as rock compound, silt flow, clay rotational, earth flow, sand flow, debris flow, and mud flow [0-0]. The Madhuban landslide was a 'debris flow'-type landslide, where a large amount of soil mass flows in a steep channel during intense flooding. The stream bed damages the slope, causing massive sediment movement. The channel created by debris flow is about 45 meters

from the landslide crown. As the soil mass flows under the debris-type landslide, the change in the failing slope's volume is restricted due to the movement within confined boundaries. This leads to pore-pressure building up, leading to soil mass liquefaction and decreased shear strength, making the slope unstable. As the flow moves downstream, the slope bed is weakened by erosion, adding debris to the flow [0-0].

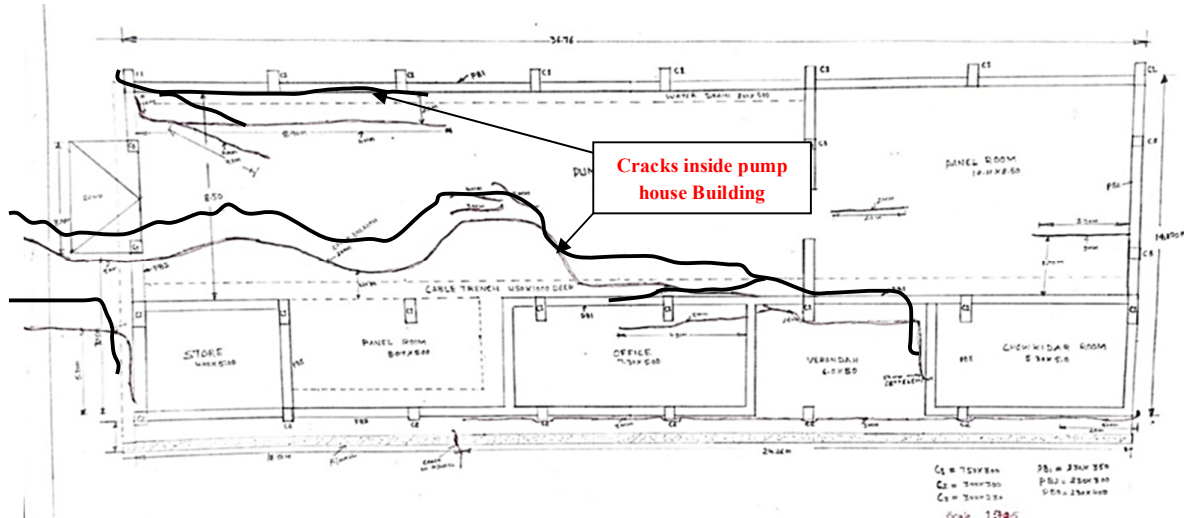

Figure 2. Location of cracks inside the Pump house building

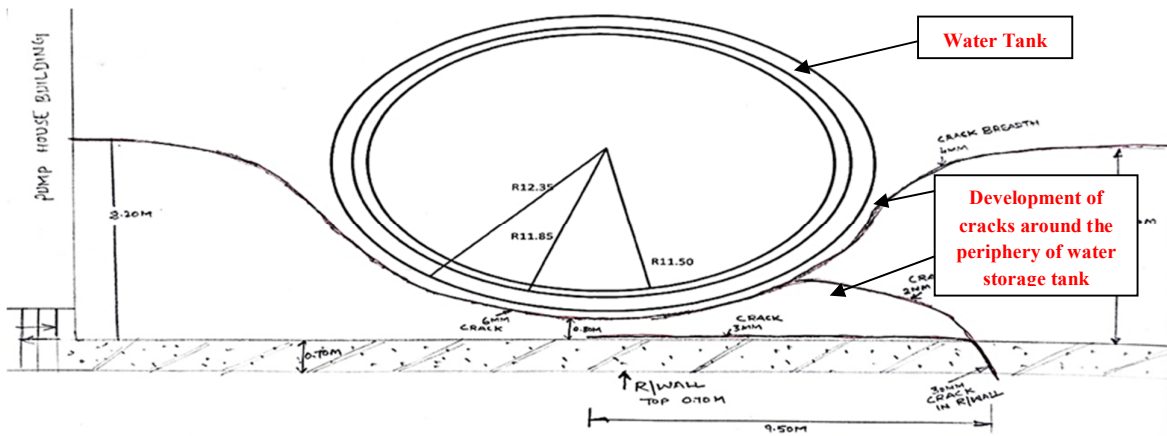

Figure 3. Location of the cracks surrounding the water tank

4. Geotechnical Investigation of Madhuban Soil

During the recent unprecedented heavy rainfall in the area, the under-construction pump house has been damaged and developed cracks due to settlement of soil underneath. The study of the geotechnical properties of Madhuban landslide soil is crucial to determine its suitability for self-drill anchors and RCC steel casing micro piles.

The samples are collected up to a depth of 4 m; however, physical characterization of soil reveals minimal variation beyond 1.5 m, and hence, results up to 1.5 m depth are only reported. The site was divided into three sections (upper, middle, and lower) along the landslide slope for sample collection. Three soil samples from each section are collected using the core cutter method in open pits at varying depths of 0.5 m, 1 m, and 1.5 m. Nine disturbed soil samples were collected,

sealed, and transported to the Geotechnical Engineering Laboratory at the National Institute of Technology in Hamirpur, India, for characterization in accordance with IS: code 14680-1999 [0]. For characterization of soil samples grain size analysis, direct shear test, triaxial shear test, Atterberg limits test was performed. The parameters' results are utilized to assess the feasibility of self-driving anchors and RCC cast in situ micro piles at Madhuban slope and for FE analysis modeling. The grain size analysis is carried out using sieve analysis and hydrometer analysis on all three sections (i.e., top, middle and bottom) of Madhuban landslide at 1.5

m depth as per IS: 2720, Part-4 [0]. The study uses light compaction tests to determine dry density, as per IS: 2720, Part-7 [0]. The results show that soil samples reach a maximum dry density of 1.84 g/cc at an optimal moisture content of 10%. The 'debris flow' landslide occurs when soil bed undergoes rapid impact loading, leading to increased pore water pressure within the failing soil mass. Geotechnical investigation of Madhuban landslide soil reveals poorly graded sand due to the presence of a small fraction of available silt in the sampled soil, which can be used to assess the shear strength parameters of the landslide.

Table 1. Parameters obtained from the laboratory tests and field investigation

Properties	Soil1	Soil2	Soil3
Cohesion (c)	8.00kPa	12.00kPa	12.5kPa
Angle of internal friction (ϕ)	22.00°	32°	36°
Unit weight (γ)	15.50kN/m ³	17.50 kN/m ³	18.40 kN/m ³
Saturated unit weight(γ_{sat})	16.50 kN/m ³	18.50 kN/m ³	19.40 kN/m ³

The unconsolidated undrained (UU) test is employed to determine the shear strength parameters (C and ϕ). The literature suggests using the UU test for soil characterization in debris-type landslides, while drained analysis of soil samples is conducted using direct shear test. However, since drained and undrained shear strength parameters for sand are equal, only undrained parameters are reported. The tests are conducted under unconsolidated undrained conditions at cell pressures of 50 kPa, 100 kPa, and 200 kPa, as per IS: 2720, part-11 [0]. Table 1 shows an average value of 12kPa and 34° for c and ϕ , respectively. The cohesion value of 12kPa is attributed to the presence of moisture from slope infiltration, despite the soil being mostly poorly graded sand. Triaxial testing reveals apparent cohesion between soil particles, and the presence of fines like silt content contributes to the development of this value.

5. Theoretical Factor of Safety of Slope without any mitigation of measures

FOS is given by equation: -

$$FS = \{CA + (WCos\Psi_p - U - V Sin\Psi_p) \tan \Phi\} / [W Sin \Psi_p + V Cos \Psi_p]$$

Where A is area of wedge

$$A = (H + btan\Psi_s - Z) Cosec \Psi_p$$

Figure 5 shows the slope height is H, the tension crack depth is Z and it is located a distance B behind the slope crest. The dip of the slope above the crest is Ψ_s . When the depth of water in the tension crack is Z_w , Table 1, consists values adopted for numerical analysis, the average values of c, ϕ and γ are adopted from the table, the water forces acting on the sliding plane U and in the tension crack V are shown in Figure and are given by [24-27].

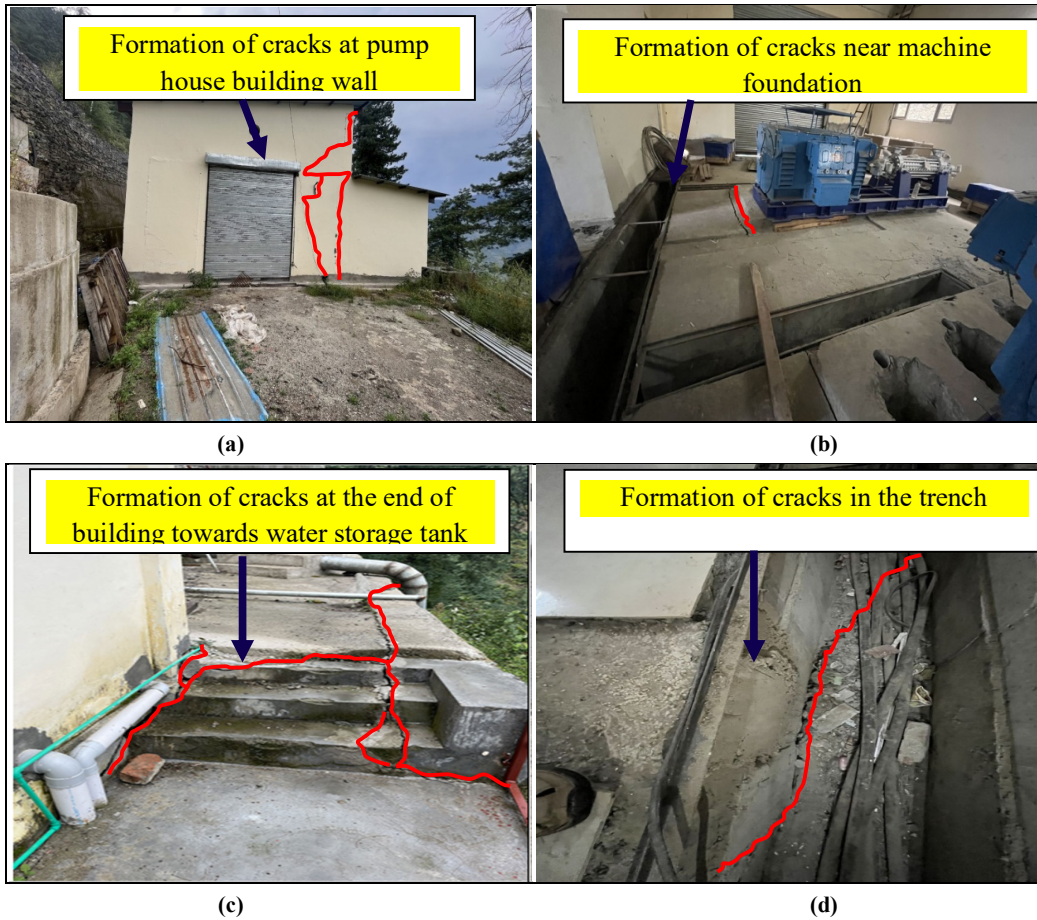

Figure 4. Shows: a) Displacement/tilt of whole structure. b) Cracks in the Pump Hall around machinery. c) End of building towards tank. d) Wide crack in the trench

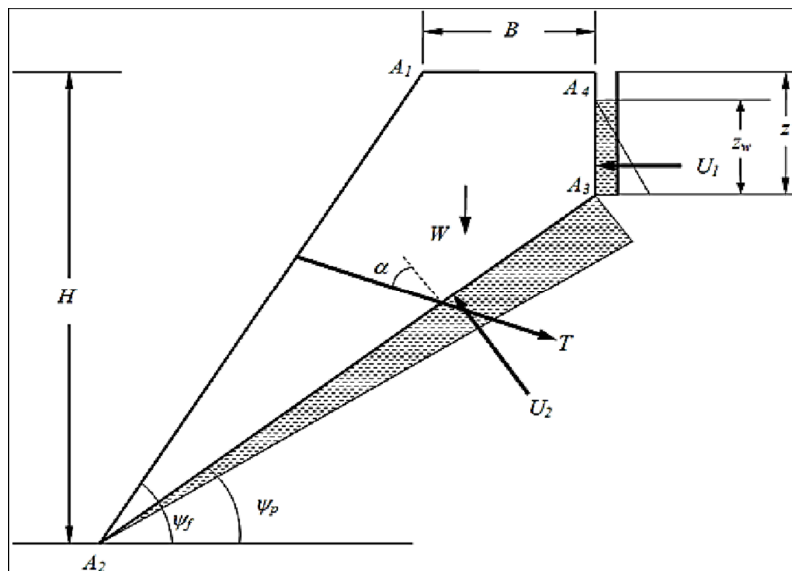

Figure 5. plane wedge failure

$$U = \frac{1}{2} \gamma_w z_w (H + b \tan \psi_s - z) \operatorname{Cosec} \psi_p$$

$$V = \frac{1}{2} \gamma_w z_w^2$$

γ_w is the unit weight of water = 10KN/m³

W = weight of the sliding block

$$W = \gamma_r [(1 - \cot \psi_f \tan \psi_p) (BH + \frac{1}{2} H^2 \cot \psi_f) + \frac{1}{2} B^2 (\tan \psi_s - \tan \psi_p)]$$

$$\gamma_r = \text{unit weight of rock} = 24\text{KN/m}^3$$

The critical tension crack depth Z_c , for a dry slope can be found by using equation

$$Z_c/H = 1 - \sqrt{\cot \Psi_f \tan \Psi_p}$$

And the corresponding position of the critical tension crack B_c behind the crest is given by

$$B_c/H = \sqrt{\cot \Psi_f \cot \Psi_p} - \cot \Psi_f$$

$$\cot \Psi_f = 0.781, \cot \Psi_p = 1.732$$

$$B_c/27 = \sqrt{\cot(52^\circ) \cot(30^\circ)} - \cot(52^\circ)$$

$$B_c = 10.3\text{m}$$

$$Z_c/H = 1 - \sqrt{\cot \Psi_f \tan \Psi_p}$$

$$Z_c/27 = 1 - \sqrt{0.781 * 0.577}$$

$$Z_c = 8.87\text{m}$$

Area A can be computed using formula

$$A = (H + b \tan \Psi_s - Z) \operatorname{cosec} \Psi_p$$

$$\operatorname{Cosec}(30^\circ) = 2$$

$$A = (27 + 10.3 * 0.624 - 8.87) * 2$$

$$A = 49.114\text{m}^2$$

U the water forces acting on the sliding plane is given by

$$U = \frac{1}{2} \gamma_w Z_w (H + b \tan \Psi_s - Z) \operatorname{Cosec} \Psi_p$$

$$U = 2178.20\text{kN}$$

V the tension crack is given by

$$V = \frac{1}{2} \gamma_w Z_w^2$$

$$V = 393.38\text{kN}$$

W the weight of the sliding block is given by

$$W = \gamma_r [(1 - \cot \Psi_f \tan \Psi_p) (BH + \frac{1}{2} H^2 \cot \Psi_f) + \frac{1}{2} b^2 (\tan \Psi_s - \tan \Psi_p)]$$

$$W = 7474.88\text{kN}$$

5.1. If the tension crack is completely filled with water, then FOS is given by

$$\text{FOS} = \frac{\{CA + (W \cos \Psi_p - U - V \sin \Psi_p) \tan \Phi\}}{[W \sin \Psi_p + V \cos \Psi_p]}$$

$$\text{FOS} = 0.874$$

5.2. If tension crack is partially filled with water i.e. $\frac{3}{4}$ of Z then FOS is given by

$$Z_w = Z_c * \frac{3}{4}$$

$$Z_w = 8.87 * 0.75 = 6.65\text{m}$$

U the water forces acting on the sliding plane is given

$$U = \frac{1}{2} \gamma_w Z_w (H + b \tan \Psi_s - Z) \operatorname{Cosec} \Psi_p$$

$$U = 1633.0538\text{KN}$$

V the tension crack is given by

$$V = \frac{1}{2} \gamma_w Z_w^2$$

$$V = 221.1125\text{KN}$$

$$\text{FOS} = \frac{\{CA + (W \cos \Psi_p - U - V \sin \Psi_p) \tan \Phi\}}{[W \sin \Psi_p + V \cos \Psi_p]}$$

$$\text{FOS} = 1.067$$

Table3. Calculated parameters for limit equilibrium method (LEM) analysis

Parameters	Units
H	27m
Ψ_f	52°
Ψ_p	30°
Ψ_s	32°
A	49.114m^2
W	7474.88kN
$\cos \Psi_p$	0.866°
$\sin \Psi_p$	0.50°
U	2178.20kN
V	393.38kN
$\tan \Phi$	0.762°

5.3. If the slope were drained so that there was no water in the tension crack, $Z_w = 0\text{m}$, $U = 0$, $V = 0$, the FOS is given by

$$\text{FOS} = \frac{\{CA + (W \cos \Psi_p - U - V \sin \Psi_p) \tan \Phi\}}{[W \sin \Psi_p + V \cos \Psi_p]}$$

$$\text{FOS} = 1.41$$

5.4. If the slope is drained and the cohesion on the sliding plane is reduced from 12Kpa to zero by vibrations, then new FOS is

$$\text{FOS} = \frac{\{CA + (W \cos \Psi_p - U - V \sin \Psi_p) \tan \Phi\}}{[W \sin \Psi_p + V \cos \Psi_p]}$$

$$\text{FOS} = 1.22$$

The loss of cohesion reduces the FOS from 1.41 to 1.22 which illustrates the sensitivity of the slope to the cohesion on the sliding plane.

5.5. The FOS of a plane failure using the pseudo static method is given by

$$\text{FOS} = \frac{cA + W (\cos \Psi_p - K_H \sin \Psi_p) \tan \Phi}{W (\sin \Psi_p + K_H \cos \Psi_p)}$$

K_H , the design horizontal seismic coefficient shall be determined by following expression

$$K_H = Z I S_a / 2R_g$$

Where, Z = Zone factor, based on location = 0.36 for Zone V

I = Importance Factor, for Important Structures = 1.5

Sa/g = Design acceleration coefficient for different type of soil and rock = 2.5

R = Response Reduction Factor = 3

Calculated Horizontal Seismic Coefficient (K_H) = 0.225

Vertical Seismic Coefficient (K_v) = 0.14 (2/3 of K_H)

Therefore, FOS = 0.94

5.6. Slope reinforcement with anchors is calculated using formula, in this case the slope is drained and the cohesion is zero, that is

$$C=U=V=0$$

Therefore, for a reinforcement force of T of 250KN/m installed at a dip angle Ψ_T of 45°, the FOS is given by

$$FOS = [W \cos \Psi_p + T \sin (\Psi_T + \Psi_p)] \tan \theta / [W \sin \Psi_p - T \cos (\Psi_T + \Psi_p)]$$

$$FOS = 1.34$$

5.7. If anchors are installed at a flatter angle $\Psi_T = 20^\circ$, then FOS is given by

$$FOS = [W \cos \Psi_p + T \sin (\Psi_T + \Psi_p)] \tan \theta / [W \sin \Psi_p - T \cos (\Psi_T + \Psi_p)]$$

$$FOS = 1.41$$

5.8. If anchors are installed at flatter angle $\Psi_T = 10^\circ$, then FOS is given by

$$FOS = [W \cos \Psi_p + T \sin (\Psi_T + \Psi_p)] \tan \theta / [W \sin \Psi_p - T \cos (\Psi_T + \Psi_p)]$$

$$FOS = 1.45$$

Therefore 1.45 < 1.5 (unsafe) NOT ACCEPTABLE



Figure 6. Position of telltale before and after near machine foundation

6. Numerical Modeling using Finite Element Method GEO5 Software

The finite element method (FEM) was utilized to simulate the actual site condition using GEO5 software. The contour map of the area is collected from the state PWD Department and plotted in AutoCAD and interface points are obtained from it. After that an interface of slope is drawn on GEO5 with the help of interface points. The slope is divided into three different sections that carry

different soil properties given in table. Model of slope is drawn on Geo5, properties of soil, Surcharge load of 100KN/m², 150 KN/m² and seismic forces acting on the field are defined in the Geo5 and stability analysis is performed with and without the use of mitigation of measures. Check on FOS is made on every stage and if FOS exceeds 1.5 then the slope is to be considered safe against all the forces and loads acting on it [0-0].

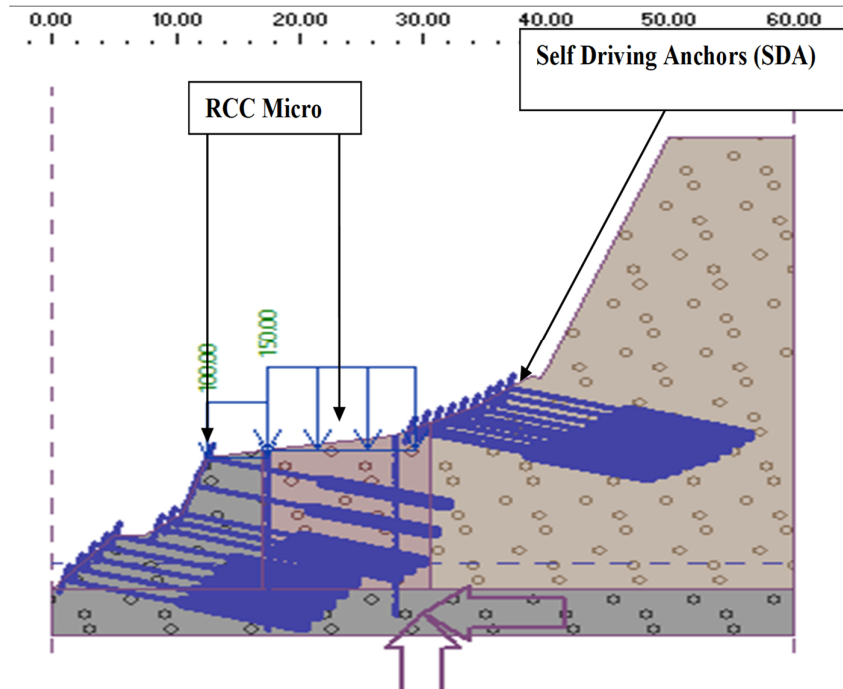

Figure 7. Typical view of slope having surcharge over it and location of micro piles

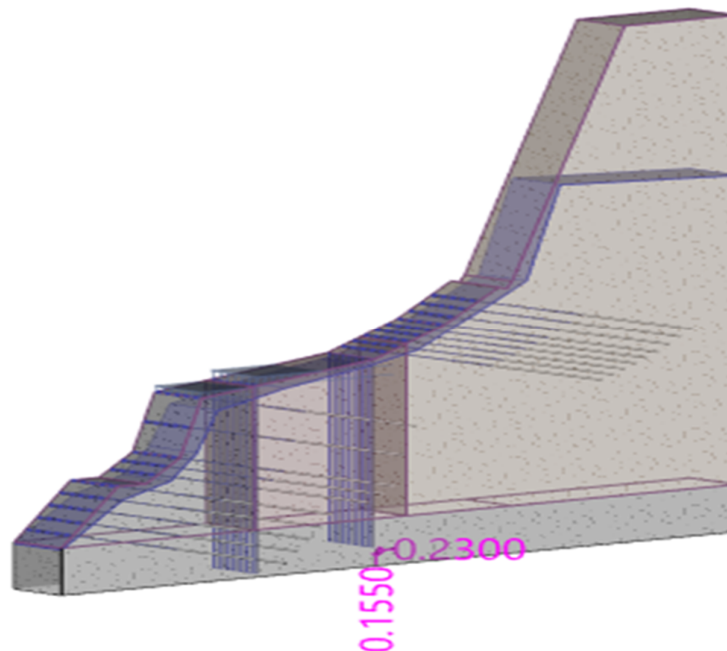

Figure 8. 3D view of location of anchors, micro piles and seismic load in Horizontal and Vertical Direction

The tensile strength of SDA and micro piles can be obtained by using the given equations below:

- a) Tensile strength of SDA = $\pi d L S_b$
 d = Diameter of anchor, L = Length of anchor, S_b = Safe bond strength for different rock conditions = 0.35-0.70 N/mm² (as per IS: 14448)

- b) Strength of micro piles = $Q_u = A_p N_c C_p + \sum \alpha_i C_i$
 $A_{si} = 500\text{KN}$ (IS 2911-1-2 (2010) Design and construction of pile foundation).

The first term gives the end-bearing resistance and the second term gives the skin friction resistance.

Where, A_p = cross-sectional area of pile tip, in m²

N_c = bearing capacity factor, may be taken as 9

C_p = average cohesion at pile tip, in kN/m^2

\sum^n = summation for layers 1 to n in which the pile is installed and which contribute to positive skin friction

α_i = adhesion factor for the i th layer depending on the consistency of soil

C_i = average cohesion for the i th layer, in kN/m^2

A_{si} = surface area of pile shaft in the i th layer, in m^2 .

Modeling parameters adopted for the design of slope using geo5 software are shown in Table 4. The view of slope having surcharge over it and location of self-drilling anchors and micro piles and dynamic load values adopted are shown in Figure 7 and Figure 8.

Table 4. Parameters adopted for numerical analysis

Parameters	Values (Units)
Model	Mohor–Coulomb (MC)
Vertical height of Slope	27m
Anchor Type	SDA (Self Drilling anchors)
Pile Type	Micro piles of RCC
Anchors spacing	1m
Length of SDA	20 m (10m free length and 10m root length)
Length of Pile	15m
Piles Spacing	0.5m
Diameter of Anchors	32mm
Diameter of Piles	200mm
Tensile strength of anchors	250kN
Strength of Piles	500kN
Surcharge load on slope surface (due to store building and water tank)	100kN/m and 150kN/m

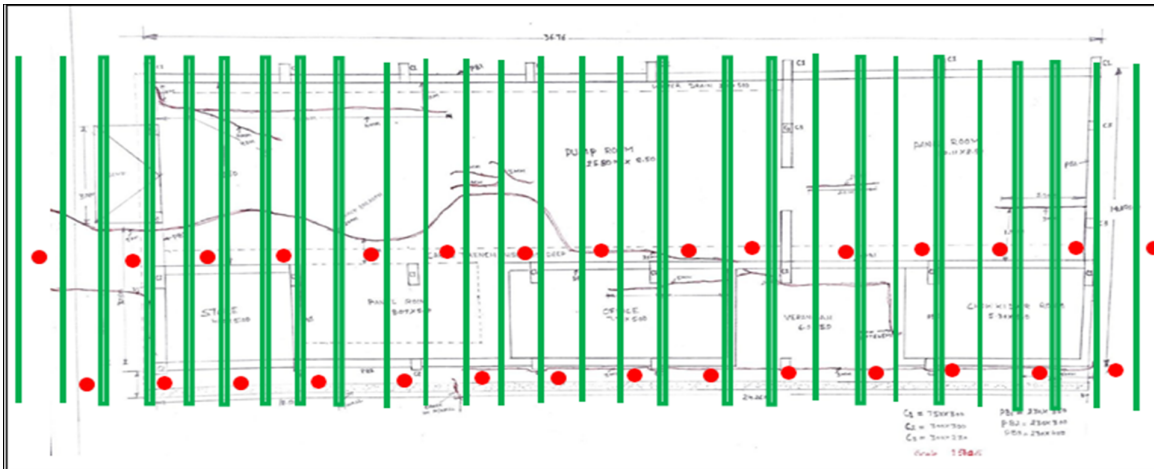

Figure 9. Location of SDA's (green bars) and micro-piles (red dots) around building

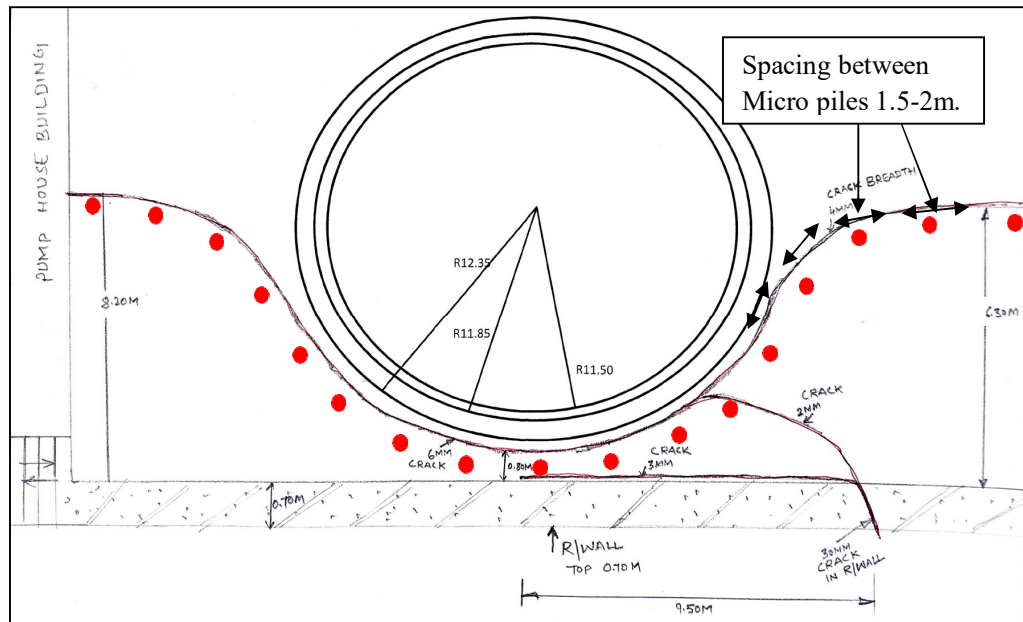

Figure 10. Location of micro-piles (red dots) around water tank

7. Finite Element Results for Factor of Safety

The factor of safety (FOS) calculation yields a value which is found to become concurrent at failure time. The analysis of the original unreinforced Madhuban slope reveals that as deformation occurs, the soil tends to detach itself from the slope, resulting in landslides due to the transition of soil into its plastic state. The top of the slope detaches itself as it cuts off from the remaining slope under tension, and slip failure occurs along the zone where the soil has moved into plastic deformation. The factor of safety for the unreinforced Madhuban slope cannot be determined as it fails, indicating a FOS <1. However, after installing SDAs and micro piles, an increase in the factor of safety is obtained. If the slip surface is found to intersect with the SDAs and micro piles, the pullout resistance is mobilized and contributes toward internal stability [0]. The unreinforced Madhuban slope has a factor of safety of 0.84, but it increases to 1.60 according to Bishop, Fellenius/Petterson FS = 1.64, Spencer FS = 4.42, Janbu FS = 4.38, Morgenstern-Price FS = 4.38, with the use of SDA and micro piles. The percentage increase in factor of safety is 50.89% with SDA and micro

piles in Bishop method. It is recommended to install SDAs (32 mm diameter up to at least 20 m length or refusal) downhill face of the slope, made of Fe 500 grade steel, at a spacing of 1m in both directions and Installation of micro piles (200 mm diameter 15 m long with M30 micro concrete reinforced with 6 HYSD bars of 12 mm diameter with 8 mm diameter spiral @ 150 mm pitch inside the building in the cable trench throughout the length of slope as shown in the Figure 9 and Figure 10 and in staggered pattern spaced 1.5 m c/c and around the slope in single row to intercept the perceptible cracks along the hillside to arrest the propagation of cracks and to intercept critical slip circle shown in Figure 11 (if any) well within the slope mass to ensure long term structural safety.

Therefore, FOS Values obtained from different methods by Geo5 shown in Figure 12 are given below:

Bishop FOS = 1.60 > 1.5 (Acceptable)

Fellenius/Petterson FOS = 1.64 > 1.5 (Acceptable)

Spencer FOS = 4.42 > 1.5 (Acceptable)

Janbu FOS = 4.38 > 1.5 (Acceptable)

Morgenstern-Price FOS = 4.38 > 1.5 (Acceptable)

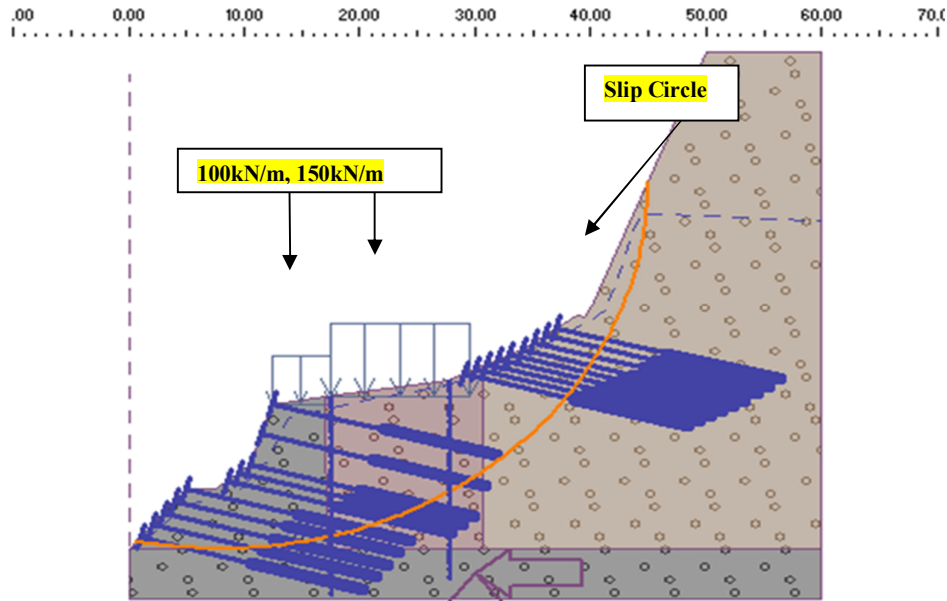

Figure 11. Location of slip circle of slope

Slope stability verification (all methods)

Bishop :	FS = 1.60 > 1.50	ACCEPTABLE
Fellenius / Petterson :	FS = 1.64 > 1.50	ACCEPTABLE
Spencer :	FS = 4.42 > 1.50	ACCEPTABLE
Janbu :	FS = 4.38 > 1.50	ACCEPTABLE
Morgenstern-Price :	FS = 4.38 > 1.50	ACCEPTABLE

Figure 12. FOS after application of mitigation of measures from Different methods

8. Validation of Factor of Safety

It is observed from theoretical calculations (LEM) that FOS is 1.45 under dry conditions, which is less than the overall stability (FOS = 1.5) and the FEM gives a FOS of 1.60, 1.64, 4.42, 4.38, 4.38, which is >1.5 and is obtained by GEO5. The difference in LEM factor of safety and FEM factor of safety may be due to the fact that LEM primarily involves equilibrium of forces acting on soil wedge, whereas FEM-based GEO5 software considers elastic-plastic deformation of nodes. The FEM is more accurate as it takes into consideration SDA and micro piles interaction while SDAs are only considered as stabilizing force in LEM.

9. Conclusions

The study investigates the Madhuban landslide through geotechnical investigation, LEM evaluation, and FEM analysis using SDAs and micro piles. It compares the factor of safety, surcharge load, and deformation forces of unreinforced and reinforced Madhuban slopes.

The results suggest mitigation using SDA and micro piles for Madhuban landslide mitigation, leading to the following conclusions:

1. The Madhuban slope collapsed without self-drilling anchors and micro piles, indicating a factor of safety (FOS) of <1 . However, using self-drilling anchors and micro piles increased the FOS to 1.67, surpassing the global safety factor 1.5. This suggests that slope stabilization can be achieved using the given design.
2. The original Madhuban slope's deformation is reduced for unreinforced and reinforced slopes, respectively. Numerical analysis of SDAs and micro piles on the Madhuban slope shows slope displacements are within permissible limits, indicating their feasibility under serviceability conditions.
3. The distribution of SDAs and micro piles forces indicates that they generate sufficient tensile forces, indicating efficient reinforcing action of the installed SDA and micro piles.

References

- [1]. FSI Technical Manual (2014) Helical piles and anchors, hydraulically driven push piers, polyurethane injection, supplemental support systems, 2nd edn. Foundation Supportworks@ Inc, Omaha
- [2]. IS 10270: Guidelines for design and construction of prestressed rock anchors
- [3]. IRC: SP: 109-2015 Guidelines for design and construction of small diameter piles
- [4]. Kim, N. K., Park, J. S. & Kim, S. K.(2007) Numerical simulation of ground anchors. *Comput. Geotech.* 34(6), 498–507.
- [5]. Liu, X., Wang, J., Jie, H. & Jiang, H. (2017). Full-scale pullout tests and analyses of ground anchors in rocks under ultimate load conditions. *Eng. Geol.* 228, 1–10.
- [6]. Bransby, M. F. and Springman, S. M. (1996). “3-D Finite element modelling of pile groups adjacent to surcharge load.” *Computers and Geotechnics*, Vol. 19, No. 4, 301–324.
- [7]. Kelesoglu, M. K. and Cinicioglu, S. F. (2010). “Free-field measurements to disclose lateral reaction mechanism of piles subjected to soil movements.” *Journal Geotechnical and Geoenvironmental Engineering*, Vol. 136, No. 2, 331–343.
- [8]. Soga K, Alonso E, Yerro A, Kumar K, Bandara S (2015) Trends in large-deformation analysis of landslide mass movements with particular emphasis on the material point method. *Geotechnique* 66(3):248–273
- [9]. Talukdar P, Bora R, Dey A (2018) Numerical investigation of hill slope instability due to seepage and anthropogenic activities. *Indian Geotech J* 48(3):585–594.
- [10]. K.U. Arun,P. Jisna (2020)A Comparison Study on Stability of Kuranchery Slopes Using GEO5 and PLAXIS 2D Software.
- [11]. A Burman, S. P.Acharya (2015) A comparative study of slope stability analysis using traditional limit equilibrium method and finite element method.
- [12]. XiangyuChe & Lulu Zhang (2019) Slope stability analysis based on the Coupled Eulerian-Lagrangian finite element method.
- [13]. Bayesteh, H., Sabermahani, M. &Elahi, H.R.(2020) Comparison of the Performance of Self-Drilled Hollow Bar and Strand Anchors in Soft Soil: A field Study. *GeotechGeolEng* 38, 5925–5939.
- [14]. Sassa K (1985) The mechanism of debris flows. In: Proceedings, 11th international conference on soil mechanics and foundation engineering, San Francisco, vol 1, pp 1173–1176
- [15]. Hungr O, Leroueil S, Picarelli L (2013) The Varnes classification of landslide types, an update. *Landslides* 11:167–194
- [16]. V Sarfarazi, H Haeri, M FatehiMarji, G Saeedi (2023), the 2D discrete element analyses of the transversely isotropic elastic geo-materials; insight to scale effects and loading rate *Journal of Mining and Environment*
- [17]. Singh, P., & Mittal, S. Finite element slope stability analyses of a slope in the Himalayan region of India considering self-drilling anchors.
- [18]. Simonetta, Cola, et al. (2012) "Reinforcement works for the slope stabilization: Standard and new approaches for the use of micropiles and anchors." *Proceedings of the 11th International Workshop on Micropiles, ISM, Milano, Italy.*
- [19]. Gutiérrez-Martín, Alfonso, et al. (2021)"Calculation of micropiles and anchors to reinforce a slope in emergency situations: Application in Málaga, Spain." *Geomatics, Natural Hazards and Risk* 12.1: 716-740.
- [20]. IS: code 14680:1999 (1999) Landslide control guidelines. Bureau of Indian Standard (BIS), New Delhi
- [21]. IS: 2720 – 4 (1985) Grain size analysis. Bureau of Indian Standard (BIS), New Delhi
- [22]. IS: 2720 - 7 (1983) Methods of test for soils: determination of water content—dry density relation using light compaction. Bureau of Indian Standard (BIS), New Delhi
- [23]. IS: 2720 - 11 (1991) Methods of test for soils: determination of shear strength parameters by unconsolidated undrainedtriaxial compression without measurement of pore water pressure. Bureau of Indian Standard (BIS), New Delhi
- [24]. Bathurst, R.J., Jones, C.J.F.P. (2001). Earth Retaining Structures and Reinforced Slopes. In: Rowe, R.K. (eds) *Geotechnical and Geoenvironmental Engineering Handbook*. Springer, Boston, MA.
- [25]. Shu-Wei Sun, Ben-Zhen Zhu, Jia-Chen Wang, (2013) Design method for stabilization of earth slopes with micropiles, *Soils and Foundations*, Volume 53, Issue 4,Pages 487-497, ISSN 0038-0806. (<https://www.sciencedirect.com/science/article/pii/S0038080613000668>)
- [26]. V Sarfarazi, A Tabaroei()Numerical investigation of effect of rock bolt angle on shear behavior of rock bridges. *Journal of Mining and Environment* 11(4), 1007-1022.
- [27]. Juneja, G. and Sharma, R.K., 2022. Numerical Investigation of Square Footing Positioned on Geocell Reinforced Sand By Using Abaqus Software. *Civil and Environmental Engineering Reports*, 32(2),154-173.

[28]. Juneja, G. and Sharma, R.K., 2022. Numerical Study on the Behaviour of Geocell-Reinforced Sand Layer Overlying Soft Clay Subgrade. *Indian Geotechnical Journal*,1-15.

[29]. Juneja, G. and Sharma, R.K., 2023. Experimental and Numerical Analysis of Geocell-Reinforced Base Layer with Different Infill Materials Overlying Clay. *Journal of Hazardous, Toxic, and Radioactive Waste*, 27(4), p.04023024.

[30]. Juneja, G. and Sharma, R.K., 2022. Numerical Analysis of Square and Circular Skirted Footings

Placed on Sand using PLAXIS 3D Software. *Journal of Mining and Environment*, 13(4), 1049-1066.

[31]. Zuixiong Li, Xudong Wang, Manli Sun, Wenwu Chen, QinglinGuo, Huyuan Zhang. (2011). Conservation of Jiaohe ancient earthen site in China. *Journal of Rock Mechanics and Geotechnical Engineering*, 3(3). 270-281, ISSN 1674-7755. (<https://www.sciencedirect.com/science/article/pii/S1674775515301153>).

تجزیه و تحلیل پایداری شیب ساختمان پمپ خانه و مخزن ذخیره آب در نارکاندا، هند: مطالعه موردی

ساحل کومار* و راوی کومار شارما

گروه مهندسی عمران، NIT حمیرپور (HP)، هند

ارسال ۲۰۲۴/۰۲/۰۵، پذیرش ۲۰۲۴/۰۵/۰۳

* نویسنده مسئول مکاتبات: ksahilkumar596@gmail.com

چکیده:

تجزیه و تحلیل پایداری شیب در مهندسی عمران، ارزیابی شیب‌ها در کاربردهای مختلف مانند سدها، خاکریزها، شیب‌های حفاری شده و شیب‌های طبیعی ضروری است. تکنیک‌های تحلیل پایداری شیب شامل روش‌های تعادل حدی، رویکردهای تجربی برای شیب‌های سنگ و روش‌های المان محدود یا تفاضل محدود است. مطالعه حاضر با استفاده از روش تعادل حدی (LEM) و روش اجزای محدود (FEM) به تجزیه و تحلیل پایداری شیب آسیب رسانده به مخزن ذخیره و ساختمان پمپ خانه جال شاکتی و بیباگ در مادوبان (نارکاندا) شیملا، هیماچال پرادش پرداخته و مناسب را پیشنهاد می‌کند. اقدامات کاهش دهنده در این مطالعه شیب در حالت طبیعی تجزیه و تحلیل شده و پس از اعمال اقدامات کاهش دهنده پیشنهادی با استفاده از لنگر خودران (SDA) یا/و ریز شمع‌های RCC برای هر دو شرایط استاتیک و دینامیکی در شرایط خشک و مرطوب تجزیه و تحلیل شد. مقادیر FOS به دست آمده توسط LEM در حالت طبیعی در شرایط خشک و اشباع استاتیک ۱.۴۱ و ۰.۸۷۵ و شرایط اشباع دینامیک ۰.۹۵ است. FOS به دست آمده پس از اعمال اقدامات کاهش دهنده توسط SDA در زاویه $\theta = 10^\circ$ درجه ۱.۴۵ است. مقادیر FOS به دست آمده از آنالیز FEM در حالت طبیعی در شرایط خشک استاتیک و اشباع ۱.۵۲ و ۰.۹۸ است. شرایط اشباع دینامیک و ۰.۵۵ می‌باشد. FOS به دست آمده با استفاده از ترکیب میکرو شمع‌های SDA و RCC و در شرایط استاتیک خشک و اشباع ۲.۷۵ و ۲.۲۳ و با استفاده از تحلیل دینامیکی در شرایط خشک و اشباع ۲.۰۰ و ۱.۶۰ می‌باشد.

کلمات کلیدی: پایداری شیب، پایداری استاتیک و دینامیکی، ضریب ایمنی، GEOS.